

GeoMax Zone20 HV

User Manual



Introduction

Purchase

Congratulations on the purchase of a GeoMax Rotating Laser product.



This manual contains important safety directions as well as instructions for setting up the product and operating it. Refer to "1 Safety Directions" for further information. Read carefully through the User Manual before you switch on the product.

Product Identification

The model and serial number of your product are indicated on the type plate. Always refer to this information when you need to contact your agency or GeoMax authorised service workshop.

Validity of this manual

This manual applies to the Zone20 HV lasers. Differences between the models are marked and described.

Available documentation

Name	Description/Format		
Zone20 HV Quick Guide	Provides an overview of the product. Intended as a quick reference guide.	✓	✓
Zone20 HV User Manual	All instructions required in order to operate the product to a basic level are contained in the User Manual. Provides an overview of the product together with technical data and safety directions.	-	✓

Refer to the following resources for all Zone20 HV documentation/software:

- the GeoMax Zone20 HV CD
- the GeoMax website: <http://www.geomax-positioning.com>

Table of Contents

In this manual	Chapter	Page
1	Safety Directions	5
1.1	General	5
1.2	Definition of Use	5
1.3	Limits of Use	6
1.4	Responsibilities	6
1.5	Hazards of Use	6
1.6	Laser Classification	7
	1.6.1 General	7
	1.6.2 Zone20 HV	8
1.7	Electromagnetic Compatibility EMC	8
1.8	FCC Statement, Applicable in U.S.	9
1.9	ICES-003 Statement, Applicable in Canada	11
2	Description of the System	12
2.1	System Components	12
2.2	Zone20 HV Laser Components	12
2.3	Case Components	13
2.4	Setup	13
2.5	ZRC20 Remote Control	14
	2.5.1 Pairing the Zone20 HV with the ZRC20 Remote Control	14
3	Operation	15
3.1	Buttons	15
3.2	LED Indicators	15
3.3	Turning the Zone20 HV on and off	16
3.4	Automatic Mode	16
3.5	Manual Mode	16
3.6	Elevation Alert (H.I.) Function	17
4	Receiver	19
4.1	ZRB35 Receiver	19
4.2	ZRP105 Receiver	20
4.3	ZRD105, Digital Receiver	21
5	Applications	23
5.1	Setting Forms	23
5.2	Checking Grades	23
5.3	Manual Grades	24
5.4	Batter Boards	25
5.5	Suspended Ceilings	26
5.6	Layout	27
5.7	More Applications	28
6	Batteries	29
6.1	Operating Principles	29
6.2	Battery for Zone20 HV	29
7	Accuracy Adjustment	31
7.1	Checking the Level Accuracy	31
7.2	Adjusting the Level Accuracy	31
8	Troubleshooting	34
8.1	Zone20 HV	34
9	Care and Transport	36
9.1	Transport	36
9.2	Storage	36
9.3	Cleaning and Drying	36
10	Technical Data	37
10.1	Conformity to National Regulations	37
	10.1.1 Zone20 HV	37
10.2	Dangerous Goods Regulations	37
10.3	General Technical Data of the Laser	37
	10.3.1 ZRC20 Remote Control	38

1 Safety Directions

1.1 General

Description The following directions enable the person responsible for the product, and the person who actually uses the equipment, to anticipate and avoid operational hazards.

The person responsible for the product must ensure that all users understand these directions and adhere to them.





About Warning Messages Warning messages are an essential part of the safety concept of the instrument. They appear wherever hazards or hazardous situations can occur.

Warning messages...

- make the user alert about direct and indirect hazards concerning the use of the product.
- contain general rules of behaviour.

For the users' safety, all safety instructions and safety messages shall be strictly observed and followed! Therefore, the manual must always be available to all persons performing any tasks described here.

DANGER, WARNING, CAUTION and NOTICE are standardised signal words for identifying levels of hazards and risks related to personal injury and property damage. For your safety, it is important to read and fully understand the following table with the different signal words and their definitions! Supplementary safety information symbols may be placed within a warning message as well as supplementary text.

Type	Description
 DANGER	Indicates an imminently hazardous situation which, if not avoided, will result in death or serious injury.
 WARNING	Indicates a potentially hazardous situation or an unintended use which, if not avoided, could result in death or serious injury.
 CAUTION	Indicates a potentially hazardous situation or an unintended use which, if not avoided, may result in minor or moderate injury.
NOTICE	Indicates a potentially hazardous situation or an unintended use which, if not avoided, may result in appreciable material, financial and environmental damage.
	Important paragraphs which must be adhered to in practice as they enable the product to be used in a technically correct and efficient manner.

1.2 Definition of Use

Intended use

- The product casts a horizontal laser plane or a laser beam for the purpose of alignment.
- The laser beam can be detected by means of a laser detector.
- Remote control of product.
- Data communication with external appliances.

Reasonably foreseeable misuse

- Use of the product without instruction.
- Use outside of the intended use and limits.
- Disabling safety systems.
- Removal of hazard notices.
- Opening the product using tools, for example screwdriver, unless this is permitted for certain functions.
- Modification or conversion of the product.
- Use after misappropriation.
- Use of products with obvious damages or defects.
- Use with accessories from other manufacturers without the prior explicit approval of GeoMax.
- Inadequate safeguards at the working site.
- Deliberate dazzling of third parties.
- Controlling of machines, moving objects or similar monitoring application without additional control and safety installations.

1.3 Limits of Use

Environment Suitable for use in an atmosphere appropriate for permanent human habitation: not suitable for use in aggressive or explosive environments.

 **DANGER** Local safety authorities and safety experts must be contacted before working in hazardous areas, or close to electrical installations or similar situations by the person in charge of the product.

1.4 Responsibilities

Manufacturer of the product GeoMax AG, CH-9443 Widnau, hereinafter referred to as GeoMax, is responsible for supplying the product, including the user manual and original accessories, in a safe condition.

Person responsible for the product The person responsible for the product has the following duties:

- To understand the safety instructions on the product and the instructions in the user manual.
- To ensure that it is used in accordance with the instructions.
- To be familiar with local regulations relating to safety and accident prevention.
- To inform GeoMax immediately if the product and the application becomes unsafe.
- To ensure that the national laws, regulations and conditions for the operation of e.g. radio transmitters or lasers are respected.

1.5 Hazards of Use

 **CAUTION** Watch out for erroneous measurement results if the product has been dropped or has been misused, modified, stored for long periods or transported.
Precautions: Periodically carry out test measurements and perform the field adjustments indicated in the user manual, particularly after the product has been subjected to abnormal use as well as before and after important measurements.

 **DANGER** Because of the risk of electrocution, it is dangerous to use poles, levelling staffs and extensions in the vicinity of electrical installations such as power cables or electrical railways.
Precautions: Keep at a safe distance from electrical installations. If it is essential to work in this environment, first contact the safety authorities responsible for the electrical installations and follow their instructions.



NOTICE With the remote control of products, it is possible that extraneous targets will be picked out and measured.
Precautions: When measuring in remote control mode, always check your results for plausibility.

 **WARNING** If the product is used with accessories, for example masts, staffs, poles, you may increase the risk of being struck by lightning.
Precautions: Do not use the product in a thunderstorm.

 **WARNING** Inadequate securing of the working site can lead to dangerous situations, for example in traffic, on building sites and at industrial installations.
Precautions: Always ensure that the working site is adequately secured. Adhere to the regulations governing safety, accident prevention and road traffic.

 **CAUTION** If the accessories used with the product are not properly secured and the product is subjected to mechanical shock, for example blows or falling, the product may be damaged or people can sustain injury.
Precautions: When setting-up the product, make sure that the accessories are correctly adapted, fitted, secured, and locked in position. Avoid subjecting the product to mechanical stress.

 **CAUTION** During the transport, shipping or disposal of batteries it is possible for inappropriate mechanical influences to constitute a fire hazard.

Precautions:

Before shipping the product or disposing of it, discharge the batteries by running the product until they are flat.

When transporting or shipping batteries, the person in charge of the product must ensure that the applicable national and international rules and regulations are observed. Before transportation or shipping contact your local passenger or freight transport company.

WARNING

During dynamic applications, for example stakeout procedures there is a danger of accidents occurring if the user does not pay attention to the environmental conditions around, for example obstacles, excavations or traffic.

Precautions:

The person responsible for the product must make all users fully aware of the existing dangers.

WARNING

If you open the product, either of the following actions may cause you to receive an electric shock.

- Touching live components
- Using the product after incorrect attempts were made to carry out repairs

Precautions:

Do not open the product. Only GeoMax authorised service workshops are entitled to repair these products.

WARNING

If the product is improperly disposed of, the following can happen:

- If polymer parts are burnt, poisonous gases are produced which may impair health.
- If batteries are damaged or are heated strongly, they can explode and cause poisoning, burning, corrosion or environmental contamination.
- By disposing of the product irresponsibly you may enable unauthorised persons to use it in contravention of the regulations, exposing themselves and third parties to the risk of severe injury and rendering the environment liable to contamination.

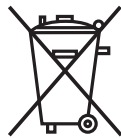
Precautions:

The product must not be disposed with household waste.

Dispose of the product appropriately in accordance with the national regulations in force in your country.

Always prevent access to the product by unauthorised personnel.

Product-specific treatment and waste management information can be downloaded from the GeoMax website at <http://www.geomax-positioning.com/treatment> or received from your GeoMax distributor.

WARNING

Only GeoMax authorised service workshops are entitled to repair these products.

WARNING

High mechanical stress, high ambient temperatures or immersion into fluids can cause leakage, fire or explosions of the batteries.

Precautions:

Protect the batteries from mechanical influences and high ambient temperatures. Do not drop or immerse batteries into fluids.

WARNING

If battery terminals are short circuited e.g. by coming in contact with jewellery, keys, metalized paper or other metals, the battery can overheat and cause injury or fire, for example by storing or transporting in pockets.

Precautions:

Make sure that the battery terminals do not come into contact with metallic objects.

1.6 Laser Classification**1.6.1 General****General**

The following chapters provide instructions and training information about laser safety according to international standard IEC 60825-1 (2014-05) and technical report IEC TR 60825-14 (2004-02). The information enables the person responsible for the product and the person who actually uses the equipment, to anticipate and avoid operational hazards.



According to IEC TR 60825-14 (2004-02), products classified as laser class 1, class 2 and class 3R do not require:

- laser safety officer involvement,
- protective clothes and eyewear,
- special warning signs in the laser working area

if used and operated as defined in this User Manual due to the low eye hazard level.



National laws and local regulations could impose more stringent instructions for the safe use of lasers than IEC 60825-1 (2014-05) and IEC TR 60825-14 (2004-02).

1.6.2

Zone20 HV

General

The rotating laser built into the product produces a visible laser beam which emerges from the rotating head.

The laser product described in this section is classified as laser class 2 in accordance with:

- IEC 60825-1 (2014-05): "Safety of laser products"

These products are safe for momentary exposures but can be hazardous for deliberate staring into the beam. The beam may cause dazzle, flash-blindness and after-images, particularly under low ambient light conditions.

Zone20 HV:

Description	Value
Maximum average radiant output power	0.7 mW / 2.1 mW
Pulse duration (effective)	cw - 1.1 ms
Pulse repetition frequency	cw - 10 Hz
Beam divergence	0.2 mrad
Wavelength	635 nm

CAUTION

From a safety perspective, class 2 laser products are not inherently safe for the eyes.

Precautions:

- 1) Avoid staring into the beam or viewing it through optical instruments.
- 2) Avoid pointing the beam at other people or at animals.

Labelling

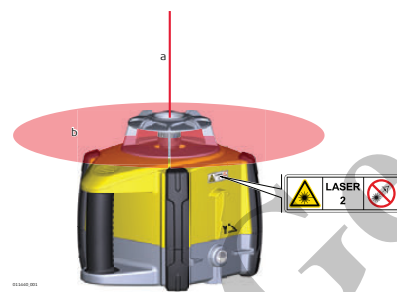

a), b) Laser beam

Laser Radiation Do not stare into the beam Class 2 Laser Product according to IEC 60825-1 (2014 - 05) P _{av} = 2.1 mW λ = 635 nm tp = 1.1 ms
--

1.7

Electromagnetic Compatibility EMC

Description

The term Electromagnetic Compatibility is taken to mean the capability of the product to function smoothly in an environment where electromagnetic radiation and electrostatic discharges are present, and without causing electromagnetic disturbances to other equipment.

WARNING

Electromagnetic radiation can cause disturbances in other equipment.

Although the product meets the strict regulations and standards which are in force in this respect, GeoMax cannot completely exclude the possibility that other equipment may be disturbed.

CAUTION

There is a risk that disturbances may be caused in other equipment if the product is used with accessories from other manufacturers, for example field computers, personal computers or other electronic equipment, non-standard cables or external batteries.

Precautions:

Use only the equipment and accessories recommended by GeoMax. When combined with the product, they meet the strict requirements stipulated by the guidelines and standards. When using computers or other electronic equipment, pay attention to the information about electromagnetic compatibility provided by the manufacturer.

CAUTION

Disturbances caused by electromagnetic radiation can result in erroneous measurements.

Although the product meets the strict regulations and standards which are in force in this respect, GeoMax cannot completely exclude the possibility that the product may be disturbed by intense electromagnetic radiation, for example, near radio transmitters, two-way radios or diesel generators.

Precautions:

Check the plausibility of results obtained under these conditions.

CAUTION

If the product is operated with connecting cables attached at only one of their two ends, for example external supply cables, interface cables, the permitted level of electromagnetic radiation may be exceeded and the correct functioning of other products may be impaired.

Precautions:

While the product is in use, connecting cables, for example product to external battery, product to computer, must be connected at both ends.

Radios or Digital Cellular Phones

WARNING

Use of product with radio or digital cellular phone devices:

Electromagnetic fields can cause disturbances in other equipment, in installations, in medical devices, for example pacemakers or hearing aids and in aircraft. It can also affect humans and animals.

Precautions:

Although the product meets the strict regulations and standards which are in force in this respect, GeoMax cannot completely exclude the possibility that other equipment can be disturbed or that humans or animals can be affected.

- Do not operate the product with radio or digital cellular phone devices in the vicinity of filling stations or chemical installations, or in other areas where an explosion hazard exists.
- Do not operate the product with radio or digital cellular phone devices near to medical equipment.
- Do not operate the product with radio or digital cellular phone devices in aircraft.

1.8

FCC Statement, Applicable in U.S.



The greyed paragraph below is only applicable for products without radio.

WARNING

This equipment has been tested and found to comply with the limits for a Class B digital device, pursuant to part 15 of the FCC rules.

These limits are designed to provide reasonable protection against harmful interference in a residential installation.

This equipment generates, uses and can radiate radio frequency energy and, if not installed and used in accordance with the instructions, may cause harmful interference to radio communications. However, there is no guarantee that interference will not occur in a particular installation.

If this equipment does cause harmful interference to radio or television reception, which can be determined by turning the equipment off and on, the user is encouraged to try to correct the interference by one or more of the following measures:

- Reorient or relocate the receiving antenna.
- Increase the separation between the equipment and the receiver.
- Connect the equipment into an outlet on a circuit different from that to which the receiver is connected.
- Consult the dealer or an experienced radio/TV technician for help.

WARNING

Changes or modifications not expressly approved by GeoMax for compliance could void the user's authority to operate the equipment.

Labelling Zone20 HV



Labelling receiver

ZRB35:

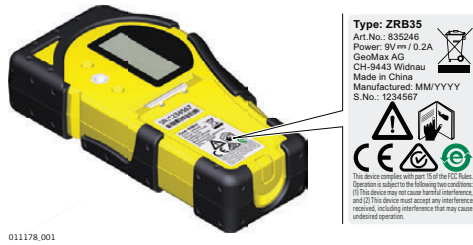

Labelling receiver

ZRP105:

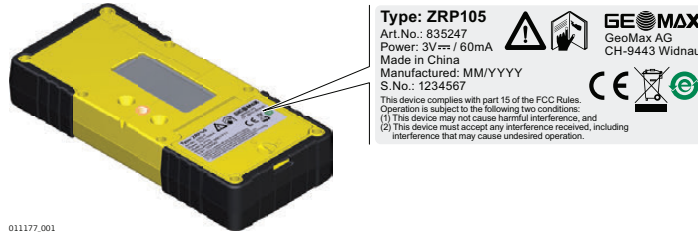

Labelling receiver

ZRD105:

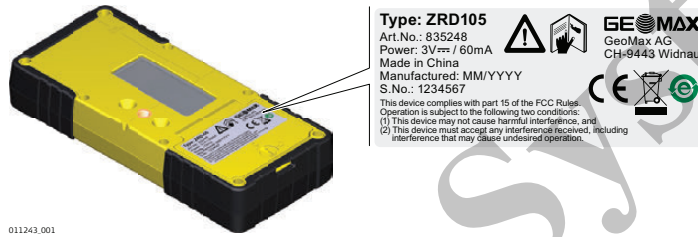

Labelling ZRC20

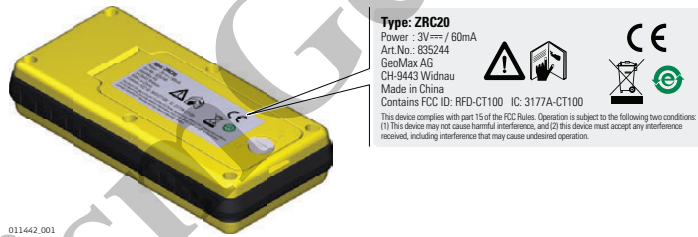

1.9

ICES-003 Statement, Applicable in Canada

⚠ WARNING

This Class (B) digital apparatus complies with Canadian ICES-003.
 Cet appareil numérique de la classe (B) est conforme à la norme NMB-003 du Canada.

2 Description of the System

2.1 System Components

General description

The Zone20 HV is a laser tool for general construction and levelling applications such as

- Setting forms
- Checking grades
- Controlling depths for excavations

If set up within the self-levelling range, the Zone20 HV automatically levels to create an accurate horizontal or vertical plane of laser light.

Once the Zone20 HV has levelled, the head will start rotating and the Zone20 HV is ready for use.

30 seconds after the Zone20 HV has completed the levelling, the H.I. Alert system becomes active and protects the Zone20 HV against changes in elevation caused by movement of the tripod to ensure accurate work.

Available system components

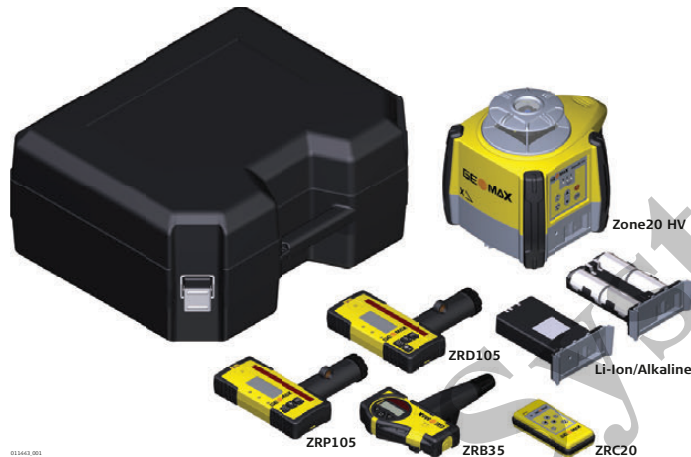

The delivered components depend on the package ordered.

2.2 Zone20 HV Laser Components

Zone20 HV laser components



- a) Carry Handle
- b) LED Indicators
- c) Buttons
- d) Battery compartment
- e) Charge LED (for Li-Ion battery pack)

2.3

Case Components

Case components

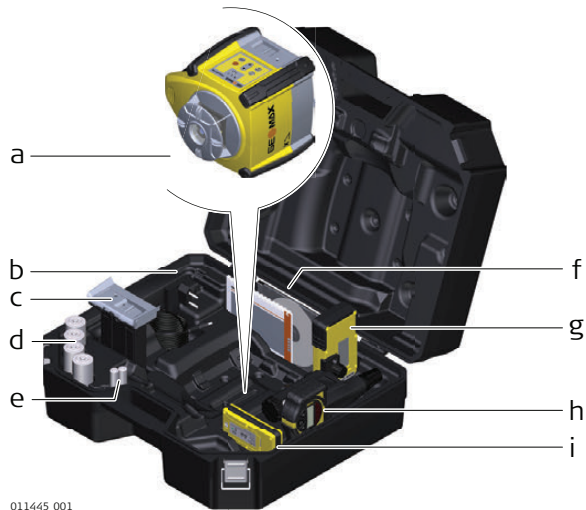

011445.001

- a) Zone20 HV laser
- b) Charger (for Li-Ion versions only)
- c) Li-Ion battery pack or Alkaline battery pack
- d) 4 x D-cell battery (for alkaline versions only)
- e) 2x AA-cell battery
- f) User Manual/CD
- g) Receiver mounted on the bracket
- h) Second receiver (can be purchased separately)
- i) ZRC20 remote control

2.4

Setup

Location

- Keep the location clear of possible obstructions that could block or reflect the laser beam.
- Place the Zone20 HV on a stable ground. Ground vibration and extremely windy conditions can affect the operation of the Zone20 HV.
- When working in a very dusty environment place the Zone20 HV up-wind so the dirt is blown away from the laser.

Setting up on a Tripod



011446.001

Step	Description
1.	Set up the tripod.
2.	Place the Zone20 HV on the tripod.
3.	Tighten the screw on the underside of the tripod to secure the Zone20 HV on the tripod.

- Attach the Zone20 HV securely to a tripod or laser trailer, or mount on a stable level surface.
- Always check the tripod or laser trailer before attaching the Zone20 HV. Make sure all screws, bolts and nuts are tight.

- If a tripod has chains, they should be slightly loose to allow for thermal expansion during the day.
- Secure the tripod on extremely windy days.

2.5

ZRC20 Remote Control

Description

The RF Remote Control communicates with the Zone20 HV via RC (radio) and is used to control the same functions as on the laser.

ZRC20 Remote Control panel



011447_001

- a) Sending LED
- b) Left and Right Arrow buttons
- c) Up and Down Arrow buttons
- d) Scan mode button
- e) Head Speed button

Description of the buttons

Button	Function
Scan Mode	Press to change width of the scanning motion.
Left and Right Arrow	Press to tilt the Y-axis when it is in Manual Mode. In the laydown position press to align the vertical plane and 90° split beam.
Up and Down	Press to tilt the X-axis when it is in Manual Mode.
Head Speed	Press to change the speed of the head rotation.

Sending LED:

The sending LED flashes to indicate that the remote is sending a signal to the Zone20 HV.



The remote control is powered by a 2x AA batteries. replacement is the same as for the GeoMax laser receivers.

2.5.1

Pairing the Zone20 HV with the ZRC20 Remote Control

Pairing step-by-step

The Zone20 HV and the ZRC20 Remote Control include radio devices that allow the user to activate additional functions on the Zone20 HV.

When purchased together, the Zone20 HV and the ZRC20 have been paired together at the factory. Should it be necessary to pair your units after purchase, the following information is applicable.

Before using the RF features, the Zone20 HV and the Remote Control must first be paired together to be able to communicate with each other.

Step	Description
1.	Turn off the Zone20 HV.
2.	Press the Power button on the Zone20 HV for to turn on the Zone20 HV.
3.	Press and hold the Head Speed button and the Scan Mode button on the ZRC20 within 20 seconds of starting the Zone20 HV.
	The Zone20 HV beeps five times quickly when the pairing was successful.

3 Operation

3.1 Buttons

Buttons

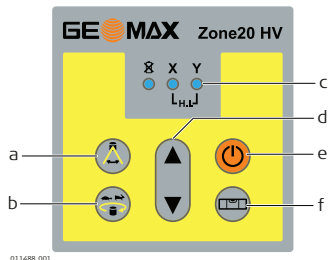

- a) Scanning button
- b) Head speed button (rps)
- c) LED indicators
- d) Up and Down Arrow buttons
- e) Power button
- f) Automatic/Manual Mode button

Description of the buttons

Button	Function
Up and Down Arrow	Press to enter a slope for an axis in Manual Mode or moves scan beam right/left.
Power	Press to turn on or off the Zone20 HV.
Automatic/Manual Mode	Press once to change the X-axis to Manual Mode with Y-axis self-levelling. Press again to change the Y-axis to Manual Mode with X-axis self-levelling. Press again to change both axes to Manual Mode with no self-levelling. Press again to change back to Full Automatic Mode. Note the changes in the LED indicators in the Manual Modes. The red LED indicates that the corresponding axis is in Manual Mode.
Scanning	Press to change the width of the scanning beam. 5°/10°/20°/30°.
Head Speed	Press to change the speed of the head rotation. 2/5/10 rps.

3.2 LED Indicators

Main functions

Description

The LED Indicators have three main functions:

- To indicate the level status of the axes.
- To indicate the battery status.
- To indicate an H.I. Alert condition.

Diagram of the LED Indicators

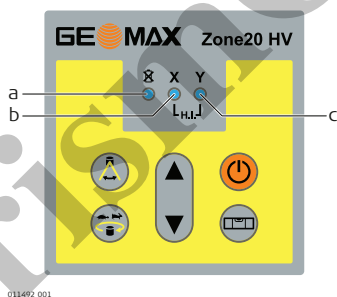

- a) Low Battery Indicator LED
- b) X-axis Indicator LED
- c) Y-axis Indicator LED

Description of the LEDs

IF	LED	THEN
Low Battery Condition (Li-Ion)	Low battery LED blinks at 1Hz.	10% remaining.
	Low battery LED blinks at 5Hz.	5% remaining.
	Low battery LED on for up to 5 minutes.	All functions are disabled and unable to power the Zone20 HV. Customer action required: Charge battery.

IF	LED	THEN
Low Battery Condition (Alkaline)	Low battery LED blinks at 1Hz.	Batteries are low.
	Low battery LED blinks at 5Hz.	Batteries are very low.
	Low battery LED on for up to 5 minutes.	All functions are disabled and unable to power the Zone20 HV. Customer action required: Replace batteries.
X-axis and Y-axis Indicator LEDs	green	the axis is level.
	flashing green	the axis is levelling.
	red	the axis is in Manual Mode.
	both flashing red	an H.I. Alert is indicated.

3.3 Turning the Zone20 HV on and off

Turning on and off Press the Power button to turn on or off the Zone20 HV.

After turning on:

- If set up within the +/-6° self-levelling range (horizontal or vertical), the Zone20 HV automatically levels to create an accurate horizontal plane of laser light.
- Once levelled, the head starts rotating and Zone20 HV is ready for use.

3.4 Automatic Mode

Description of the automatic mode The Zone20 HV always starts up in automatic mode. In automatic mode the Zone20 HV automatically levels if set up within the +/-6° self-levelling range (horizontal or vertical).

3.5 Manual Mode

Description of the Manual Mode After start-up the Manual Mode can be activated. In Manual Mode the self-levelling will be deactivated. The following options are available:

- Change the X-axis to Manual Mode
- Change the Y-axis to Manual Mode
- Change to Full Manual Mode

 After turning the Zone20 HV off and on again, the Zone20 HV is in Automatic Mode.

Changing the X-axis to Manual Mode After startup, press the Automatic/Manual Mode button once to change the X-axis to Manual Mode.  The X-axis and Y-axis are marked on the top of the Zone20 HV.

- The X-axis does not self-level and a slope can be entered in this axis using the Up and Down Arrow buttons on the Zone20 HV.
- The X-axis LED is red.
- The Y-axis continues to self-level and the Y-axis LED flashes green until level.



When the X-axis is in Manual Mode, the X-axis can be sloped upwards or downwards as illustrated.



Changing the Y-axis to Manual Mode Press the Automatic/Manual Mode button again to change the Y-axis to Manual Mode.  The X-axis and Y-axis are marked on the top of the Zone20 HV.

- The Y-axis does not self-level and a slope can be entered in this axis using the Up and Down Arrow buttons on the Zone20 HV.

- The Y-axis LED is red.
- The X-axis continues to self-level and the X-axis LED flashes green until level.



When the Y-axis is in Manual Mode, the Y-axis can be sloped upwards or downwards as illustrated.

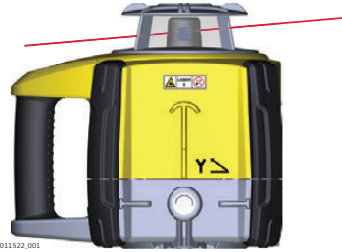

011522_001

Changing to Full Manual Mode

Press the Automatic/Manual Mode button again to change to Full Manual Mode.

The X and Y axes are marked on the top of the Zone20 HV.

- Both the X-axis and Y-axis do not self-level and a slope can be entered in the Y-axis using the Up and Down Arrow buttons on the Zone20 HV.
- The X-axis LED is red.
- The Y-axis LED is red.



When both the X-axis and Y-axis are in Manual Mode, the Y-axis can be sloped using the Up and Down Arrow buttons.



011522_001

When using the ZRC20 Remote Control, each of the axes can be sloped independently.

3.6

Elevation Alert (H.I.) Function

Description of the Elevation Alert function

- The Elevation Alert or Height of Instrument (H.I.) function prevents incorrect work caused by movement or settling of the tripod that would cause the laser to level at a lower height.
- The Elevation Alert function becomes active and monitors the movement of the laser 30 second after the Zone20 HV has levelled and the head of the laser starts rotating.
- The Elevation Alert monitors the laser. If disturbed, both the X-axis LED and Y-axis LED flash and the Zone20 HV beeps rapidly.
- To stop the alert turn Zone20 HV off and on again. Check the height of the laser before beginning to work again.

The Elevation Alert function turns on automatically every time the Zone20 HV is turned on.

Disable or enable the Elevation Alert function

As factory setting the H.I. Alert is enabled on the Zone20 HV. To disable the H.I. Alert do the following:

Step	Description
1.	Press the Power button to turn on the Zone20 HV.
2.	Press and hold the Up and Down arrow buttons, then press the Automatic/manual mode button. Now you can toggle between enabling and disabling the H.I. Alert.
3.	The internal audio indicator beeps once to indicate the change.
	The change is saved until the procedure is repeated.

Description

The Zone20 HV is sold with the ZRB35, ZRP105 or ZRD105 Receiver.

4.1

ZRB35 Receiver

**Instrument components
part 1 of 2**



011190.001

- a) Level vial
- b) Keypad
- c) On-grade
- d) Laser Reception window
- e) LCD window
- f) Audio Speaker

Component	Description
Level vial	Aids to keep the rod plumb when taking readings.
Keypad	Power, accuracy and volume functions.
On-grade	Indicates the on-grade position of the laser.
Laser Reception window	Detects the laser beam. The reception windows must be directed towards the laser.
LCD window	Front and rear LCD arrow indicate the detector's position.
Audio Speaker	Indicates the detector's position: <ul style="list-style-type: none"> • High - Fast beeping • On-grade - Solid tone • Low - Slow beeping

**Instrument components
part 2 of 2**



005666.001

- a) Bracket Mounting Hole
- b) Offset notch
- c) Battery door
- d) Serial number label
- e) Product label

Component	Description
Bracket Mounting Hole	Location to attach the receiver bracket for normal operation.
Offset notch	Use to transfer reference marks. The notch is 45 mm (1.75") below to top of the detector.
Battery door	Access to the battery compartment.

**Description of the
buttons**



011190.001

- a) Audio
- b) Bandwidth
- c) Power

Button	Function
Audio	Press to change the audio output.
Bandwidth	Press to change detection bandwidth.
Power	Press once to turn on the Receiver.

Instrument components
part 1 of 2



011193.001

- a) Level vial
- b) Audio Speaker
- c) LCD window
- d) LEDs
- e) Laser Reception window
- f) On-grade
- g) Keypad

Component	Description
Level vial	Aids to keep the rod plumb when taking readings.
Audio Speaker	Indicates the detector's position: <ul style="list-style-type: none"> • High - Fast beeping • On-grade - Solid tone • Low - Slow beeping
LCD window	Front and rear LCD arrow indicate the detector's position.
LEDs	Display the relative position of the laser beam. Three channel indication: <ul style="list-style-type: none"> • High - Red • On-grade - Green • Low - Blue
Laser Reception window	Detects the laser beam. The reception windows must be directed towards the laser.
On-grade	Indicates the on-grade position of the laser.
Keypad	Power, accuracy and volume functions.

Instrument components
part 2 of 2



011194.001

- a) Bracket Mounting Hole
- b) Offset notch
- c) Product label
- d) Battery door

Component	Description
Bracket Mounting Hole	Location to attach the receiver bracket for normal operation.
Offset notch	Use to transfer reference marks. The notch is 85 mm (3.35") below to top of the detector.
Product label	The serial number is located inside the battery compartment.
Battery door	Access to the battery compartment.

Description of the
Buttons

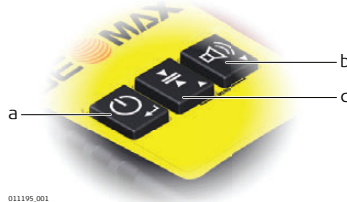

011195.001

- a) Power
- b) Audio
- c) Bandwidth

Button	Function
Power	Press once to turn on the Receiver.
Audio	Press to change the audio output.
Bandwidth	Press to change detection bandwidth.

Menu access and navigation

To access the menu of the ZRP105 Receiver, press the Bandwidth button and Audio button simultaneously.

- Use the Bandwidth button and Audio button to change parameters.
- Use the Power button to scroll through the menu.

Menu

 MENU MODE - The blue LED will blink slowly indicating menu mode.

Menu	Function	Indication
LED Red and Green LEDs change brightness to indicate this parameter.	Changes the brightness of the LED indicators.	Red and green LEDs - High/Low/Off
BAT The laser icon flashes to indicate this parameter.	Turns on or off the Laser low battery indication on the receiver.	Green LED is on: Laser low battery icon function is active. Red LED is on: Laser low battery icon function is not active.
MEM The down arrow bars are filling to indicate this parameter.	Turns on or off the position memory function.	Green LED is on: function is on. Red LED is on: function is off.

4.3

ZRD105, Digital Receiver

The ZRD105 Digital Receiver provides you with basic position information by using an arrow display plus digital readout.

Instrument components

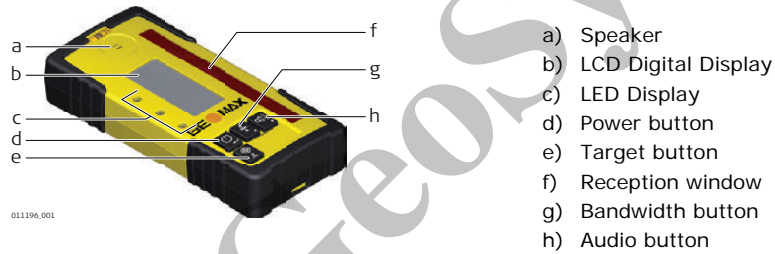

Description of the Buttons

Button	Function
Power	Press once to turn on the receiver. Press 1.5 seconds to turn off the receiver.
Target	Press to capture the digital reading.
Bandwidth	Press to change detection bandwidths.
Audio	Press to change the audio output.

5 Applications

5.1 Setting Forms

Setting Forms step-by-step

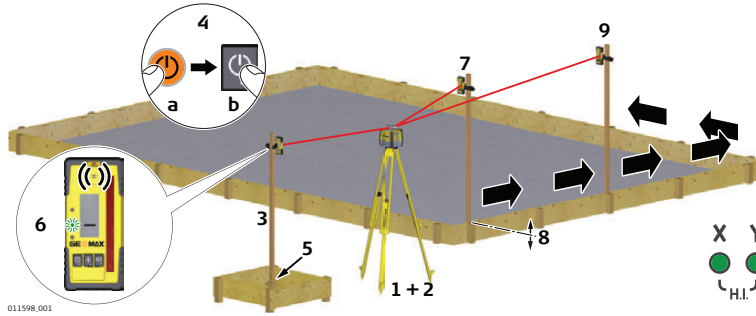

Step	Description
1.	Set up the Zone20 HV on a tripod.
2.	Set up the tripod on a stable surface outside the working area.
3.	Attach the receiver to a rod.
4.	Turn on the Zone20 HV and the receiver.
5.	Set the base of the rod on a known point for the finished height of forms.
6.	Adjust the height of the receiver on the rod until the on-grade (centre-line) position is indicated on the receiver by: <ul style="list-style-type: none"> the centre bar the green flashing LED a solid audio tone the digital display
7.	Set the rod with the attached receiver on top of the form.
8.	Adjust the height of the form until the on-grade position is again indicated.
9.	Continue to additional positions until the forms are levelled to the rotating plane of the Zone20 HV.

5.2 Checking Grades

Checking Grades step-by-step

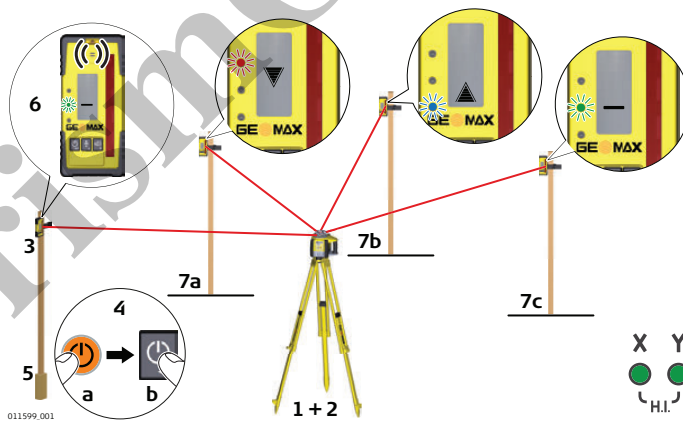

Step	Description
1.	Set up the Zone20 HV on a tripod.
2.	Set up the tripod on a stable surface outside the working area.
3.	Attach the receiver to a rod.
4.	Turn on the Zone20 HV and the receiver.
5.	Set the base of the rod on a known point for the finished grade.

Step	Description
6.	Adjust the height of the receiver on the rod until the on-grade (centre-line) position is indicated on the receiver by: <ul style="list-style-type: none"> the centre bar the green flashing LED a solid audio tone the digital display
7.	Set the rod with the attached receiver on top of the excavation or concrete pour to check for correct elevation.
8.	Variances can be read in precise measurements with the digital receiver. <ul style="list-style-type: none"> 7a: Position is too high. 7b: Position is too low. 7c: Position is on grade.

5.3

Manual Grades

Manual Grading step-by-step

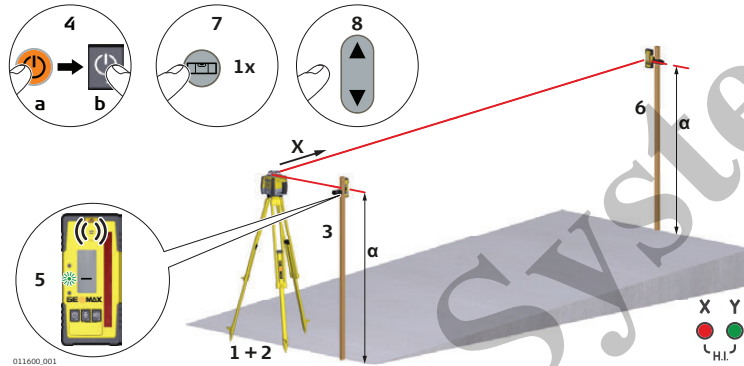

Step	Description
1.	Set up the Zone20 HV on a tripod.
2.	Set up the tripod at the base of a slope with the x-axis pointing in the direction of the slope.
3.	Attach the receiver to a rod.
4.	Turn on the Zone20 HV and the receiver.
5.	At the base of the slope, adjust the height of the receiver on the rod until the on-grade (centre-line) position is indicated on the receiver by: <ul style="list-style-type: none"> the centre bar the green flashing LED a solid audio tone
6.	Move the rod and the attached receiver to the top of the slope.
7.	Change the X-axis to Manual Mode by pressing the Automatic/Manual Mode button once on the Zone20 HV.
8.	Use the Up and Down Arrow buttons on the Zone20 HV to move the laser beam up and down until the on-grade (centre-line) position is indicated on the receiver by: <ul style="list-style-type: none"> the centre bar the green flashing LED a solid audio tone

5.4

Batter Boards

Description

The Zone20 HV and the receiver create a vertical plane of laser light that acts as a virtual string line for batter board setups.

Setup

Laser setup

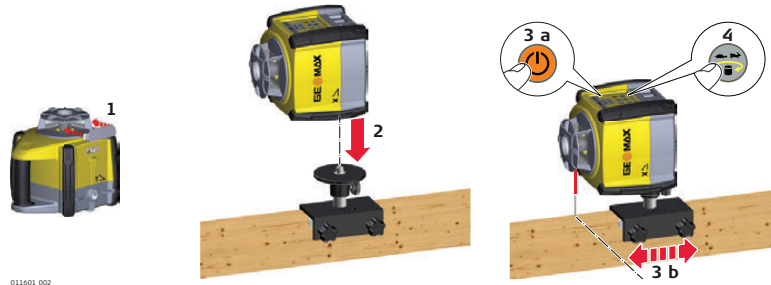

Step	Description
1.	Clip the masking plate onto the light house opposite of the keypad.
2.	Mount the Zone20 HV to the clamp and then the clamp to the batter board.
3.	Turn on the Zone20 HV. Press the Scan button and turn the beam downwards so that the laser and the clamp can be positioned directly over the surveyed reference nail.
4.	Set the head rotation to the fastest speed (10 rps).

Receiver setup



Step	Description
1.	Mount the receiver to the receiver bracket using the 90° adapter.
2.	Attach the bracket to the batter board. The top of the receiver bracket should be tight against the surveyed reference nail.
3.	Turn on the receiver.

Alignment

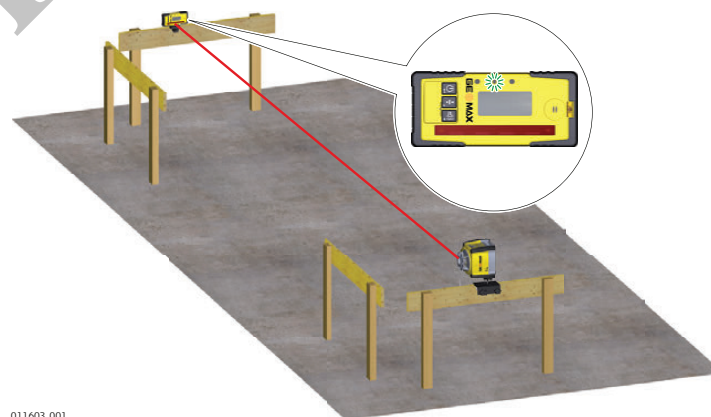

Use the remote control to move the rotating laser beam left or right until the receiver displays an on-grade position.

5.5 Suspended Ceilings

Description The Zone20 HV can also be used for suspended ceiling installations.

Mounting the laser



011607_001

Step	Description
1.	Attach the Zone20 HV to the wall mount bracket.

Application

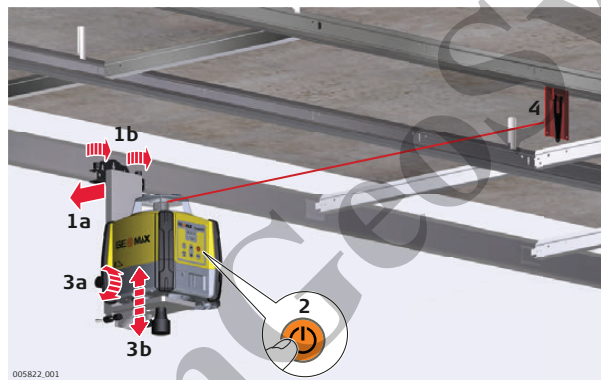

005822_001

Step	Description
1.	After mounting the first strip of ceiling trim at the desired height (centre position of the ceiling target) below, attach the wall mount bracket and laser to the trim. Tighten the locking knobs on the top of the bracket.
2.	Press the Power button to turn on the Zone20 HV and allow the Zone20 HV to self-level.
3.	Adjust the Zone20 HV so that the rotating beam is at the desired height below the ceiling grid. Loosen the adjustment knob on the side of the bracket and slide the Zone20 HV up or down. When at the desired height, retighten the adjustment knob.
4.	Install the ceiling grid using the ceiling grid target and laser beam as your reference.

Setup

When installing suspended ceilings use the remote control to change to scanning mode for increased visibility (1). The scanning beam can be rotated using the up and down buttons on the remote (2).

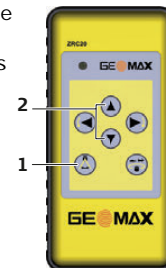

011614_001

Description

In the laying down position the Zone20 HV can be used for laying out wall positions, squaring, transferring points and more.

Layout

The Zone20 HV projects two laser beams at a 90° angle to each other.

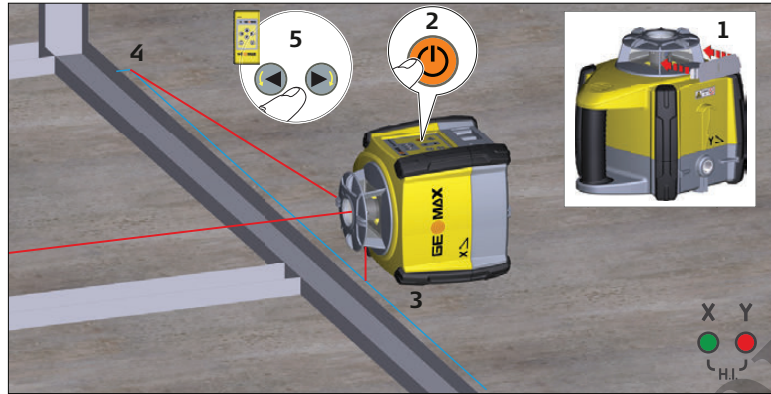

Step	Description
1.	Clip the masking plate onto the light house opposite of the keypad.
2.	Place the Zone20 HV in the laydown position and press the power button to turn on the Zone20 HV. The Zone20 HV will always turn on in Automatic Mode. Allow the Zone20 HV to self-level.
3.	Start the scan function and direct the scan beam to be on the masking plate. The scan beam on the masking plate will create a dot passing through the slot of the masking plate. Use this spot to position the laser over your reference point.
4.	Start the head rotation or scanning motion to roughly align the beam to a second control point.
5.	Using the buttons on the remote control, fine adjust the beam until striking the second control point.
6.	Once aligned the split beam and rotating beams can be used to locate 90° angles for layout. The rotating beam also creates a vertical plane for transferring points from the floor to the ceiling.

Setup

When using the Zone20 HV in the laydown position use the left or right arrow buttons on your remote control to quickly align the vertical plane or plumb beam to the second reference point. (1). The scanning beam can be moved quickly to the left or right side of the laser using the up and down button (2).

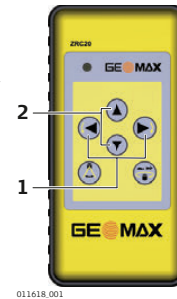

011618.001

More applications**Exterior Applications**

- Setting elevation of forms and footings
- Squaring of forms
- Checking elevations and benchmarks
- Landscaping
- Drainage and septic systems
- Fences and retaining walls
- Decks and patios
- Simple driveways or small parking lots
- Facade Installations
- Batter board setups

Interior Applications

- Suspended ceilings
 - Walls and partitions
 - Vertical alignment
 - Transferring points from floor to ceiling
 - Vertical plumb
 - Layout of floors
 - Squaring of angles
 - Setting cabinets
 - Chair rails and wainscoting
 - Alignment of wall and floor tiles
 - Trim carpentry
 - Setting sprinkler head heights
 - Sloped ceilings
-

Description The Zone20 HV can be purchased with alkaline batteries or a rechargeable Li-Ion battery pack. The following information is appropriate only to the model you have purchased.

6.1 Operating Principles

First-time Use / Charging Batteries

- The battery must be charged prior to using it for the first time because it is delivered with an energy content as low as possible.
- The permissible temperature range for charging is between 0°C and +40°C/+32°F and +104°F. For optimal charging, we recommend charging the batteries at a low ambient temperature of +10°C to +20°C/+50°F to +68°F if possible.
- It is normal for the battery to become warm during charging. Using the chargers recommended by GeoMax, it is not possible to charge the battery if the temperature is too high.
- For new batteries or batteries that have been stored for a long time (> three months), it is effectual to make only one charge/discharge cycle.
- For Li-Ion batteries, a single discharging and charging cycle is sufficient. We recommend carrying out the process when the battery capacity indicated on the charger or on a GeoMax product deviates significantly from the actual battery capacity available.

Operation / Discharging

- The batteries can be operated from -20°C to +55°C/-4°F to +131°F.
- Low operating temperatures reduce the capacity that can be drawn; high operating temperatures reduce the service life of the battery.

6.2 Battery for Zone20 HV

Charging the Li-Ion battery pack step-by-step

The rechargeable Li-Ion battery pack on the Zone20 HV can be charged without removing the battery pack from the laser.



011619.001

Step	Description
1.	Slide the locking mechanism on the battery compartment to the centre position to expose the charge jack.
2.	Plug the AC connector into the appropriate AC power source.
3.	Connect the charger plug into the charge jack on the Zone20 HV battery pack.
4.	The small LED next to the charge jack flashes indicating that the Zone20 HV is charging. The LED is on solid when the battery pack is fully charged.
5.	When the battery pack is fully charged, disconnect the charger plug from the charge jack.
6.	Slide the locking mechanism to the left position to prevent dirt from getting into the charging jack.



The battery pack reaches a full charge in approximately 5 hours if completely empty. A one-hour charge should allow the Zone20 HV to run for a full 8 hours.

Changing the Li-Ion batteries step-by-step

With the rechargeable Li-Ion battery pack the battery indicator on the Zone20 HV LCD display shows when the battery pack is low and needs to be charged.

The charge indicator LED on the Li-Ion battery pack indicates when the pack is being charged (flashing slowly) or fully charged (on, not flashing).



011620.001

Step	Description
	The batteries are inserted in the front of the laser.
	The rechargeable battery pack can be recharged without being removed from the laser. Refer to "Charging the Li-Ion battery pack step-by-step" for further information.
1.	Slide the locking mechanism on the battery compartment to the right and open the cover of the battery compartment.
2.	To remove the batteries: Remove the batteries from the battery compartment. To insert the batteries: Insert the batteries into the battery compartment.
3.	Close the cover of the battery compartment and slide the locking mechanism to the left until it locks into position.

Changing the alkaline batteries step-by-step

With alkaline batteries the battery indicator on the Zone20 HV LCD display flashes when the batteries are low and need to be replaced. If no battery icon is shown, the batteries are okay.







011621.001

Step	Description
	The batteries are inserted in the front of the laser.
1.	Slide the locking mechanism on the battery compartment to the right and open the cover of the battery compartment.
2.	To remove the batteries: Remove the batteries from the battery compartment. To insert the batteries: Insert the batteries into the battery compartment, ensuring that the contacts are facing in the right direction. The correct polarity is displayed on the battery holder.
3.	Close the cover of the battery compartment and slide the locking mechanism to the left until it locks into position.

8 Troubleshooting

8.1 Zone20 HV

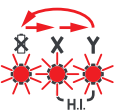
Alerts

Alert	Symptom	Possible causes and solutions
	Low Battery LED flashes red, or is on but not flashing.	The batteries are low. Replace the alkaline batteries or recharge the Li-Ion battery pack. Refer to "6 Batteries".
	Elevation (H.I.) Alert The LEDs flash quickly with an audio beep.	The Zone20 HV has been bumped or tripod was moved. Turn off Zone20 HV to stop alert check the height of the laser before beginning to work again. Allow Zone20 HV to re-level and check the height of the laser. After two minutes in the alert condition, the unit will shut off automatically.
	Servo Limit Alert All LEDs flash sequentially.	The Zone20 HV is tipped too far to reach a level position. Re-level the Zone20 HV within the 6 degree self-levelling range. This alert will also be displayed any time the unit is tipped more than 45° from level. After two minutes in the alert condition, the unit will shut off automatically.
	Temperature Alert All LEDs are on but not flashing.	The Zone20 HV is in an environment where it cannot operate without causing damage to the laser diode. This could be a result of heat from direct sunlight. Shade the Zone20 HV from the sun. After two minutes in the alert condition, the unit will shut off automatically.

Troubleshooting

Problem	Possible Cause(s)	Suggested Solutions
The Zone20 HV is working, but not self-levelling.	The Zone20 HV is in Manual Mode.	The Zone20 HV must be in Automatic Mode to self-level. Set the Zone20 HV to Automatic Mode by pressing the Automatic/Manual Mode button. <ul style="list-style-type: none"> - In Automatic Mode the X-axis LED and the Y-axis LED flash green while levelling. - In Manual Mode the X-axis LED and/or the Y-axis LED are red.
Zone20 HV does not turn on.	The batteries are low or dead.	Check the batteries and change or charge the batteries if necessary. If the problem continues, return the Zone20 HV to an authorised service centre for service.
The distance of the laser is reduced.	Dirt is reducing the laser output.	Clean the windows of the Zone20 HV and the receiver. If the problem continues, return the Zone20 HV to an authorised service centre for service.
The laser receiver is not working properly.	The Zone20 HV is not rotating. It may be levelling or in Elevation Alert.	Check for proper operation of the Zone20 HV.  Refer to the receiver manual for more information.
	The receiver is out of usable range.	Move closer to the Zone20 HV.
	The batteries of the receiver are low.	Change the receiver batteries.

Problem	Possible Cause(s)	Suggested Solutions
The Zone20 HV cannot communicate with the ZRC20 Remote Control.	The Zone20 HV and the remote have not been paired and cannot communicate with each other.	Pair the Zone20 HV and the remote. Refer to "2.5.1 Pairing the Zone20 HV with the ZRC20 Remote Control" for more information.
Elevation Alert function is not working.	The Elevation Alert function is disabled.	The Elevation Alert function is enabled or disabled by pressing the following button combination: With Zone20 HV turned on and rotating, press and hold the Left and Right Arrow buttons. Then press the Automatic/Manual Mode button to enable or disable the Elevation Alert function. The Zone20 HV beeps once to indicate the change.
The Zone20 HV does not turn on in Automatic Mode.	The Zone20 HV is designed to always turn on in Automatic Mode unless specifically disabled by the user.	The Automatic Mode can be enabled or disabled by pressing the Automatic/Manual Mode button.
The Zone20 HV turns on with the last mode saved.	The Zone20 HV is designed to always turn on in Automatic Mode unless specifically disabled by the user.	With the Zone20 HV turned on and rotating, press the power button to turn the Zone20 HV off. Press and hold both the Automatic/Manual Mode button and the power button for five seconds to enable or disable the function. The Zone20 HV will beep once to indicate the change.

9 Care and Transport

9.1 Transport

Transport in the field	When transporting the equipment in the field, always make sure that you <ul style="list-style-type: none">• either carry the product in its original transport container,• or carry the tripod with its legs splayed across your shoulder, keeping the attached product upright.
Transport in a road vehicle	Never carry the product loose in a road vehicle, as it can be affected by shock and vibration. Always carry the product in its transport container, original packaging or equivalent and secure it.
Shipping	When transporting the product by rail, air or sea, always use the complete original GeoMax packaging, transport container and cardboard box, or its equivalent, to protect against shock and vibration.
Shipping, transport of batteries	When transporting or shipping batteries, the person responsible for the product must ensure that the applicable national and international rules and regulations are observed. Before transportation or shipping, contact your local passenger or freight transport company.
Field adjustment	Periodically carry out test measurements and perform the field adjustments indicated in the User Manual, particularly after the product has been dropped, stored for long periods or transported.

9.2 Storage

Product	Respect the temperature limits when storing the equipment, particularly in summer if the equipment is inside a vehicle. Refer to "Environmental specifications" for information about temperature limits.
Field adjustment	After long periods of storage inspect the field adjustment parameters given in this user manual before using the product.
Li-Ion and alkaline batteries	For Li-Ion and alkaline batteries <ul style="list-style-type: none">• Refer to "Environmental specifications" for information about storage temperature range.• Remove batteries from the product and the charger before storing.• After storage recharge batteries before using.• Protect batteries from damp and wetness. Wet or damp batteries must be dried before storing or use. For Li-Ion batteries <ul style="list-style-type: none">• A storage temperature range of 0°C to +30°C / +32°F to +86°F in a dry environment is recommended to minimize self-discharging of the battery.• At the recommended storage temperature range, batteries containing a 30% to 50% charge can be stored for up to one year. After this storage period the batteries must be recharged.

9.3 Cleaning and Drying

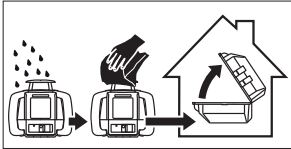
Product and accessories	<ul style="list-style-type: none">• Blow dust off lenses and prisms.• Never touch the glass with your fingers.• Use only a clean, soft, lint-free cloth for cleaning. If necessary, moisten the cloth with water or pure alcohol. Do not use other liquids; these can attack the polymer components.
Damp products	Dry the product, the transport container, the foam inserts and the accessories at a temperature not greater than 40°C / 104°F and clean them. Remove the battery cover and dry the battery compartment. Do not repack until everything is completely dry. Always close the transport container when using in the field. 
Cables and plugs	Keep plugs clean and dry. Blow away any dirt lodged in the plugs of the connecting cables.

10

Technical Data

10.1

Conformity to National Regulations

10.1.1

Zone20 HV

Conformity to National Regulations



- FCC Part 15 (applicable in US)
- Hereby, GeoMax, declares that the product/s is/are in compliance with the essential requirements and other relevant provisions of Directive 1999/5/EC and other applicable European Directives. The declaration of conformity may be consulted at <http://www.geomax-positioning.com/Downloads.htm>.
Class 1 equipment according European Directive 1999/5/EC (R&TTE) can be placed on the market and be put into service without restrictions in any EEA member state.
- The conformity for countries with other national regulations not covered by the FCC part 15 or European directive 1999/5/EC has to be approved prior to use and operation.

Frequency band

2400.0 - 2483.5 MHz

Output power

< 100 mW (e. i. r. p.)

Antenna

Zone20 HV:

Chip antenna

10.2

Dangerous Goods Regulations

Dangerous Goods Regulations

The products of GeoMax are powered by Lithium batteries.

Lithium batteries can be dangerous under certain conditions and can pose a safety hazard. In certain conditions, Lithium batteries can overheat and ignite.



When carrying or shipping your GeoMax product with Lithium batteries onboard a commercial aircraft, you must do so in accordance with the **IATA Dangerous Goods Regulations**.



GeoMax has developed **Guidelines** on "How to carry GeoMax products" and "How to ship GeoMax products" with Lithium batteries. Before any transportation of a GeoMax product, we ask you to consult these guidelines on our web page (<http://www.geomax-positioning.com/dgr>) to ensure that you are in accordance with the IATA Dangerous Goods Regulations and that the GeoMax products can be transported correctly.



Damaged or defective batteries are prohibited from being carried or transported onboard any aircraft. Therefore, ensure that the condition of any battery is safe for transportation.

10.3

General Technical Data of the Laser

Operating range

Operating range (diameter):

Zone20 HV:

900 m/3000 ft

Self-levelling accuracy

Self-levelling accuracy:

±1.5 mm at 30 m (±1/16" at 100 ft)

Self-levelling accuracy is defined at 25°C (77°F)

Self-levelling range

Self-levelling range:

±6°

Rotation speed

Rotation speed:

2, 5, 10 rps

Scanning modes

Scanning modes:

10° - 35°

Laser dimensions



Weight

Zone20 HV weight with battery: 3.09 kg/6.8 lbs.

Internal battery

Type	Operating times* at 20°C
Lithium-Ion (Li-Ion Pack)	>40 h
Alkaline (four D-cells)	>40 h

*Operating times are dependent upon environmental conditions.

- ☞ Charging the Li-Ion battery pack takes a maximum of five hours.
- ☞ Use only high quality alkaline batteries to achieve operating time.

Environmental specifications

Temperature

Operating temperature	Storage temperature
-20°C to +50°C (-4°F to +122°F)	-40°C to +70°C (-40°F to +158°F)

Protection against water, dust and sand

Protection
IPX7 (IEC 60529)
Dust tight
Protected against continuous immersion in water.

A100 Lithium-Ion charger

Type: Li-Ion battery charger
 Input voltage: 100 V AC-240 V AC, 50 Hz-60 Hz
 Output voltage: 12 V DC
 Output current: 3.0 A
 Polarity: Shaft: negative, Tip: positive

A600 Lithium-Ion battery pack

Type: Li-Ion battery pack
 Input voltage: 12 V DC
 Input current: 2.5 A
 Charge time: 5 hours (maximum) at 20°C

10.3.1

ZRC20 Remote Control

Operating range	Operating range (radius):	100 m / 300 ft
------------------------	---------------------------	----------------

Batteries	Batteries: Alkaline Battery life (typical usage)	Two AA-cells 70 hours
------------------	---	--------------------------

Remote Control Dimensions

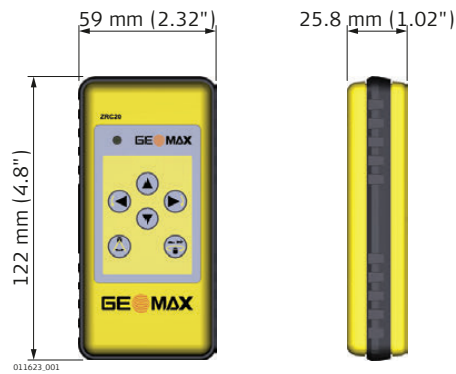

GeoMax Zone20 HV Series



842788-1.1.0en

Original text

© 2016 GeoMax AG, Widnau, Switzerland

GeoMax AG
www.geomax-positioning.com

